

# ECH381R-XXP

PCB Terminal Blocks > PCB Connector-Socket

Date:2026-04-06Version:V1

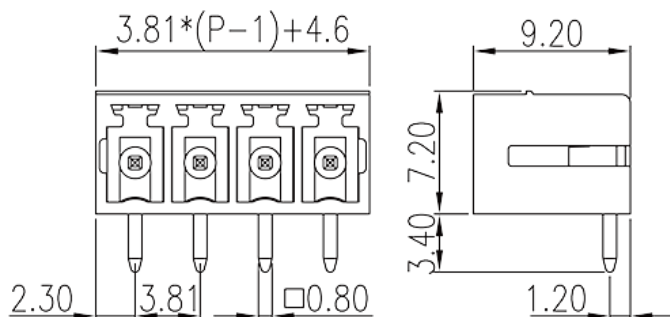

The web catalog is for reference only. Dinkle remains the right of product modification and engineering change of the design. The final product is made according to engineering drawing.

## Product Description

Pitch : 3.81 mm, 300V, 8A

## General information

Short description	PCB Connector – Socket, Wave soldering
Category	PCB Connector – Socket
Pitch (mm)	3.81
Color	Green (default)
Type of locking	Without
Soldering method	Wave soldering
Length (mm)	$3.81*(P-1)+4.6$
Width (mm)	9.2
Height (mm)	7.2
Pin demensions (Thickness x Width)(mm)	0.8x0.8
PCB hole diameter (mm)	1.2~1.3
Number of positions	02P~24P
Level	Single level

## Material information

Insulation material	PA
---------------------	----

Insulation material group	I
Flame retardant rating , compliant with UL94	V0
Insulation resistance	□500MΩ at DC 500V
Conductor material	COPPER ALLOY
Plating of conductor surface	Tin PLATED

### Connection data-IEC

Rated voltage (V)	500
Rated current (A)	14
Rated voltage (II/2)(V)	500
Rated voltage (III/2) (V)	320
Rated voltage (III/3)(V)	200
Rated impulse voltage (II/2)(KV)	2.5
Rated impulse voltage (III/2)(KV)	2.5
Rated impulse voltage (III/3)(KV)	2.5

### Connection data-UL

Rated voltage (UL/CUL Group B)(V)	300
Rated current (UL/CUL Group B)(A)	8
Rated voltage (UL/CUL Group D)(V)	300
Rated current (UL/CUL Group D)(A)	8

### Environment & Safety

Finger protection (YES or NO)	YES
Operating temperature. max (°C)	120
Operating temperature. min (°C)	-40

### UL Recognized

Rated voltage (Group B)(V)	300
Rated current (Group B)(A)	8
Rated voltage (Group D)(V)	300
Rated current (Group D)(A)	8

### CUL Recognized

Rated voltage (Group B)(V)	300
----------------------------	-----

Rated current (Group B)(A)	8
Rated voltage (Group D)(V)	300
Rated current (Group D)(A)	8

### VDE Approval

Rated voltage (V)	320
Rated current (A)	14

### Drawings

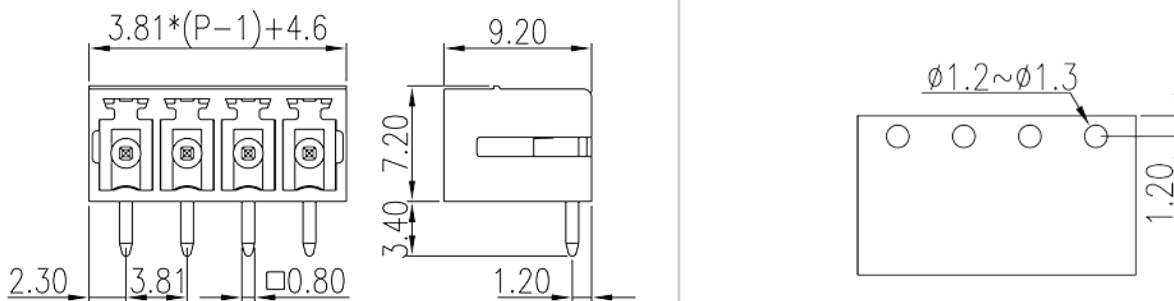

### Approvals

