

# PPAC-95

PCB Terminal Blocks > Panel Feed-Through Blocks

Date:2026-04-05Version:1.2

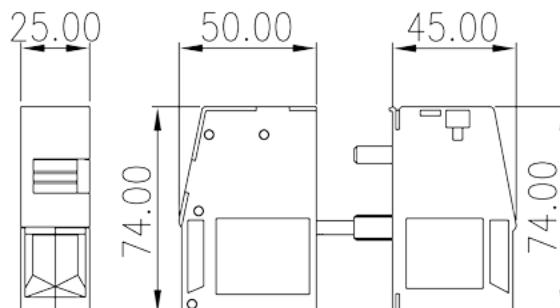

The web catalog is for reference only. Dinkle remains the right of product modification and engineering change of the design. The final product is made according to engineering drawing.

## Product Description

M8, 600V, 230A

## General information

Short description	Panel Feed-Through, Screw Connection
Category	Panel Feed-Through
Color	Grey (default)
Connection method	Screw connection
Type of locking	Without
Length (mm)	25
Width (mm)	50+45
Height (mm)	74
Number of positions	1P

## Material information

Insulation material	PA
Insulation material group	I
Flame retardant rating , compliant with UL94	V0
Insulation resistance	□500MΩ at DC 500V
Conductor material	COPPER ALLOY

Plating of conductor surface

Tin PLATED

## Connection data-IEC

Rated voltage (V)	630V (5.0 ~ 6.0mm mounting plate), 800V (2.5 ~ 5.0mm mounting plate), 1000V (1.0 ~ 2.5mm mounting plate)
Rated current (A)	232
Rated voltage (III/3)(V)	630V (5.0 ~ 6.0mm mounting plate), 800V (2.5 ~ 5.0mm mounting plate), 1000V (1.0 ~ 2.5mm mounting plate)
Rated impulse voltage (III/3)(KV)	8
Conductor cross section solid. min (mm <sup>2</sup> )	25
Conductor cross section solid.max (mm <sup>2</sup> )	95
Conductor cross section stranded. min (mm <sup>2</sup> )	25
Conductor cross section stranded. max (mm <sup>2</sup> )	95
Conductor cross section flexible, with min ferrule without plastic sleeve (mm <sup>2</sup> )	25
Conductor cross section flexible, with max ferrule without plastic sleeve (mm <sup>2</sup> )	95
Conductor cross section flexible, with min ferrule with plastic sleeve (mm <sup>2</sup> )	25
Conductor cross section flexible, with max ferrule with plastic sleeve (mm <sup>2</sup> )	95
2 conductors with same cross section, solid, min (mm <sup>2</sup> )	25
2 conductors with same cross section, solid, max (mm <sup>2</sup> )	35
2 conductors with same cross section, stranded, min (mm <sup>2</sup> )	25
2 conductors with same cross section, stranded, max (mm <sup>2</sup> )	35
2 conductors with same cross section flexible, with min ferrule without plastic sleeve (mm <sup>2</sup> )	16
2 conductors with same cross section flexible, with max ferrule without plastic sleeve (mm <sup>2</sup> )	35
Screw thread	M8
Philips screwdriver size	#6
Rated torque (N.m)	15
Stripping Length (mm)	26~27

## Connection data-UL

Rated voltage (UL/CUL Group B)(V)	600
Rated current (UL/CUL Group B)(A)	230

Rated voltage (UL/CUL Group C)(V)	600
Rated current (UL/CUL Group C)(A)	230
Min. solid wire connection (AWG) acc. to UL/CUL	4
Max. solid wire connection AWG acc. to UL/CUL	4/0
Min. stranded wire connection AWG acc. to UL/CUL	4
Max. stranded wire connection AWG acc. to UL/CUL	4/0

## Environment & Safety

Back of the hand protection (YES or NO)	YES
Finger protection (YES or NO)	YES
Operating temperature. max (°C)	120
Operating temperature. min (°C)	-40

## UL Recognized

Wire Range (Group B)(AWG)	4~4/0
Rated voltage (Group B)(V)	600
Rated current (Group B)(A)	230
Wire Range (Group C)(AWG)	4~4/0
Rated voltage (Group C)(V)	600
Rated current (Group C)(A)	230

## CUL Recognized

Wire Range (Group B)(AWG)	4~4/0
Rated voltage (Group B)(V)	600
Rated current (Group B)(A)	230
Wire Range (Group C)(AWG)	4~4/0
Rated voltage (Group C)(V)	600
Rated current (Group C)(A)	230

## Drawings

--	--

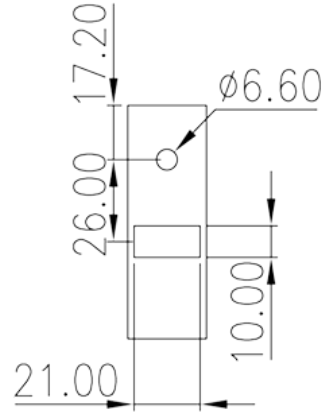
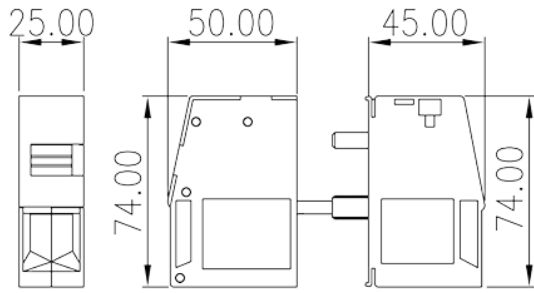

## Approvals

