

# P-871

Barrier Terminal Blocks > Wire Terminal

Date:2026-04-06Version:1.2

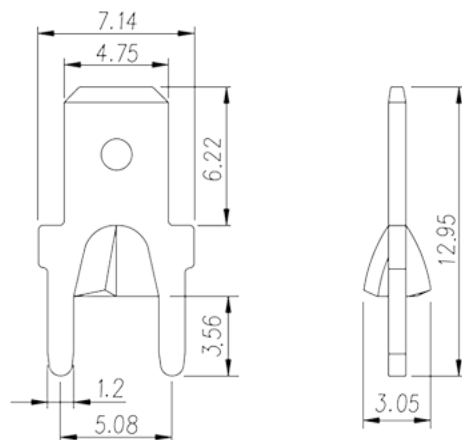

The web catalog is for reference only. Dinkle remains the right of product modification and engineering change of the design. The final product is made according to engineering drawing.

## Product Description

Pitch : 5.08mm, 0.8x1.2mm, 30A

## General information

Short description	Barrier terminal blocks, Quick terminal blocks
Category	Quick terminal blocks
Pitch (mm)	5.08
Pin demensions (Thickness x Width)(mm)	0.8x1.2

## Material information

Conductor material	COPPER ALLOY
Plating of conductor surface	Tin PLATED

## Connection data-IEC

Rated current (A)	30
-------------------	----

## Drawings

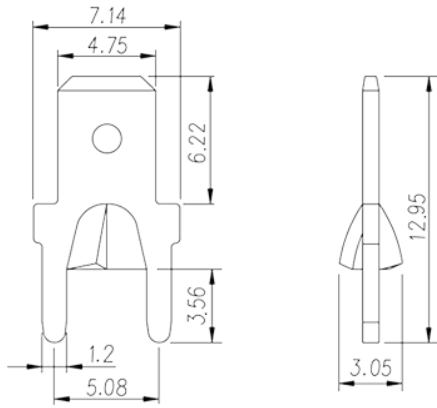

## Approvals

