

# 0168-41XX

Barrier Terminal Blocks > Panel Feed-Through

Date:2026-04-06Version:1.1

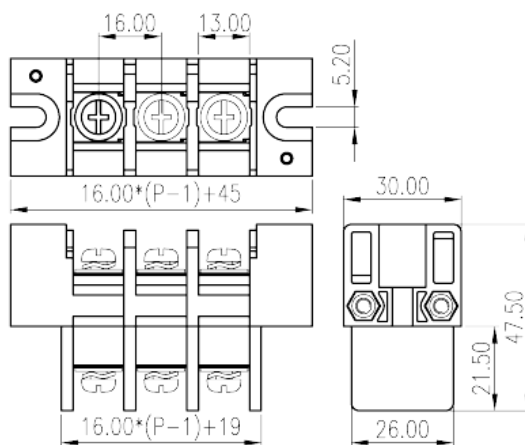
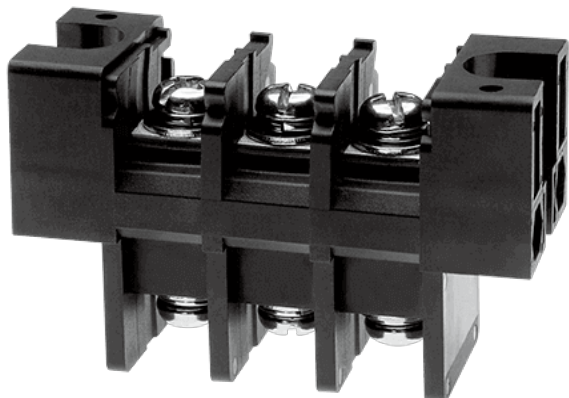

The web catalog is for reference only. Dinkle remains the right of product modification and engineering change of the design. The final product is made according to engineering drawing.

## Product Description

Pitch: 16mm , M5, 600V, 115A

## General information

Short description	Barrier terminal blocks , Screw connection
Category	Panel Feed Through Terminal Blocks
Pitch (mm)	16
Color	Black(default)
Connection method	Screw connection
Type of locking	With mounting flange
Level	Single level

## Material information

Insulation material	PBT
Insulation material group	IIIa
Flame retardant rating , compliant with UL94	V0
Conductor material	Copper Alloy
Plating of conductor surface	Tinned

## Connection data-IEC

Rated voltage (V)	1000
Rated current (A)	76
Rated voltage (II/2)(V)	1000
Rated voltage (III/2) (V)	1000
Rated voltage (III/3)(V)	1000
Rated impulse voltage (II/2)(KV)	8
Rated impulse voltage (III/2)(KV)	8
Rated impulse voltage (III/3)(KV)	8
Conductor cross section solid. min (mm <sup>2</sup> )	2.5
Conductor cross section solid.max (mm <sup>2</sup> )	16
Conductor cross section stranded. min (mm <sup>2</sup> )	2.5
Conductor cross section stranded. max (mm <sup>2</sup> )	16
2 conductors with same cross section, solid, max (mm <sup>2</sup> )	10
2 conductors with same cross section, stranded, max (mm <sup>2</sup> )	10
Screw thread	M5
Slotted screwdriver size (Blade thickness x Width)(mm)	1.0x5.5
Philips screwdriver size	PH2
Rated torque (N.m)	2.5
Recommend tightening torque. min (N.m)	2
Recommend tightening torque. max (N.m)	2.5
Stripping Length (mm)	13

## Connection data-UL

Rated voltage (UL/CUL Group B)(V)	600
Rated current (UL/CUL Group B)(A)	115
Rated voltage (UL/CUL Group C)(V)	600
Rated current (UL/CUL Group C)(A)	115
Min. solid wire connection (AWG) acc. to UL/CUL	14
Max. solid wire connection AWG acc. to UL/CUL	2
Min. stranded wire connection AWG acc. to UL/CUL	14
Max. stranded wire connection AWG acc. to UL/CUL	2

## Environment & Safety

Back of the hand protection (YES or NO)	YES
---	-----

Operating temperature. max (°C)	120
Operating temperature. min (°C)	-40

## UL Recognized

Wire Range (Group B)(AWG)	14~2
Rated voltage (Group B)(V)	600
Rated current (Group B)(A)	115
Wire Range (Group C)(AWG)	14~2
Rated voltage (Group C)(V)	600
Rated current (Group C)(A)	115

## CUL Recognized

Wire Range (Group B)(AWG)	14~2
Rated voltage (Group B)(V)	600
Rated current (Group B)(A)	115
Wire Range (Group C)(AWG)	14~2
Rated voltage (Group C)(V)	600
Rated current (Group C)(A)	115

## VDE Approval

Wire Range (mm <sup>2</sup> )	2.5~16
Rated voltage (V)	1000
Rated current (A)	76

## Drawings

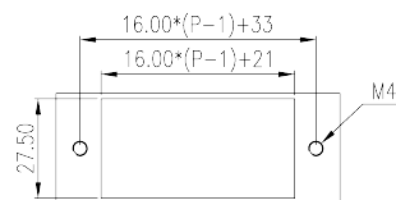
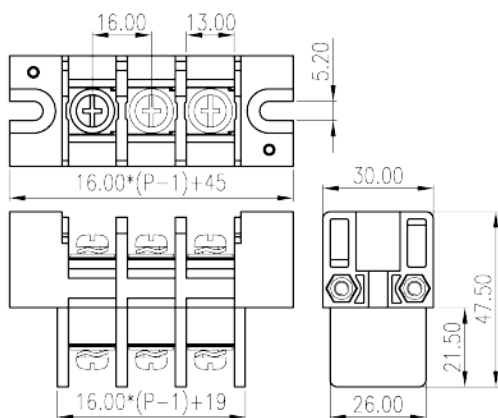

## Approvals

---

