

DKB200

NEMA Terminal Blocks > Rail Mounting

Date:2026-04-06

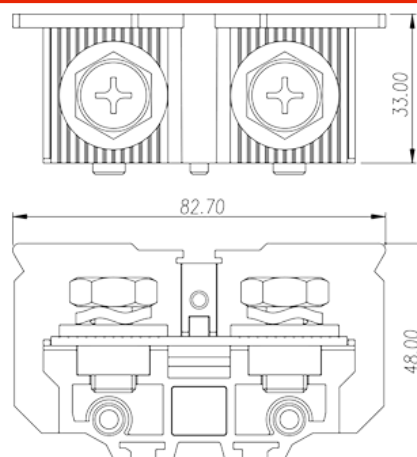
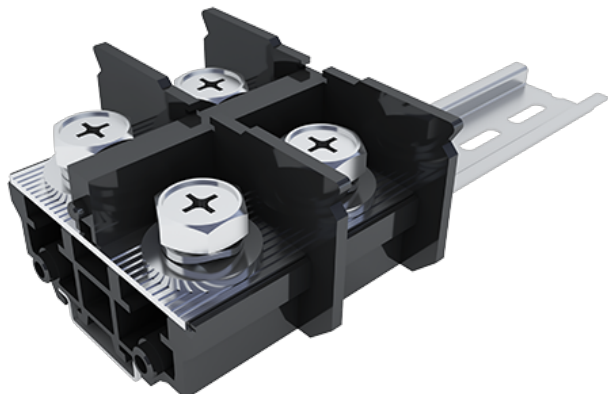

The web catalog is for reference only. Dinkle remains the right of product modification and engineering change of the design. The final product is made according to engineering drawing.

Product Description

M10, 600V, 230A

General information

| | |
|-------------------|---|
| Short description | Feed-Through single level, Screw Connection |
| Category | Feed-Through single level |
| Color | Refer to drawing |
| Connection method | Screw connection |
| Type of locking | Rail mounting |
| Length (mm) | 82.7 |
| Width (mm) | 33 |
| Height (mm) | 51.5 (TS-35N) / 59(TS-35/15N) |
| Level | Single level |
| Connection points | 2 |

Material information

| | |
|--|--------------------|
| Insulation material | PC |
| Insulation material group | IIIa |
| Flame retardant rating , compliant with UL94 | V2 |
| Insulation resistance | □1000MΩ at DC 500V |

| | |
|------------------------------|--------------|
| Conductor material | COPPER ALLOY |
| Plating of conductor surface | Ni PLATED |

Connection data-IEC

| | |
|--|--|
| Rated voltage (V) | 1000 |
| Rated current (A) | 232 |
| Rated voltage (III/3)(V) | 1000 |
| Rated impulse voltage (III/3)(KV) | 8 |
| Screw thread | M10 |
| Philips screwdriver size | PH4 |
| Rated torque (N.m) | 5 |
| Recommend tightening torque. min (N.m) | 4 |
| Recommend tightening torque. max (N.m) | 5 |
| Stripping Length (mm) | The stripping length depends on the specification provided by the cable lug manufacturer |
| Mounting rail | TS-35N · TS-35/15N |
| End cover plate required | YES |
| Grounding connections | NO |

Connection data-UL

| | |
|--|-----|
| Rated voltage (UL/CUL Group B)(V) | 600 |
| Rated current (UL/CUL Group B)(A) | 230 |
| Rated voltage (UL/CUL Group C)(V) | 600 |
| Rated current (UL/CUL Group C)(A) | 230 |
| Min. solid wire connection (AWG) acc. to UL/CUL | 8 |
| Max. solid wire connection AWG acc. to UL/CUL | 4/0 |
| Min. stranded wire connection AWG acc. to UL/CUL | 8 |
| Max. stranded wire connection AWG acc. to UL/CUL | 4/0 |

Environment & Safety

| | |
|---|-----|
| Back of the hand protection (YES or NO) | YES |
| Finger protection (YES or NO) | NO |
| Operating temperature. max (°C) | 125 |
| Operating temperature. min (°C) | -40 |

UL Recognized

| | |
|----------------------------|-------|
| Wire Range (Group B)(AWG) | 8~4/0 |
| Rated voltage (Group B)(V) | 600 |
| Rated current (Group B)(A) | 230 |
| Wire Range (Group C)(AWG) | 8~4/0 |
| Rated voltage (Group C)(V) | 600 |
| Rated current (Group C)(A) | 230 |

CUL Recognized

| | |
|----------------------------|-------|
| Wire Range (Group B)(AWG) | 8~4/0 |
| Rated voltage (Group B)(V) | 600 |
| Rated current (Group B)(A) | 230 |
| Wire Range (Group C)(AWG) | 8~4/0 |
| Rated voltage (Group C)(V) | 600 |
| Rated current (Group C)(A) | 230 |

VDE Approval

| | |
|-------------------------------|-------|
| Wire Range (mm ²) | 10~95 |
| Rated voltage (V) | 1000 |
| Rated current (A) | 232 |

Drawings

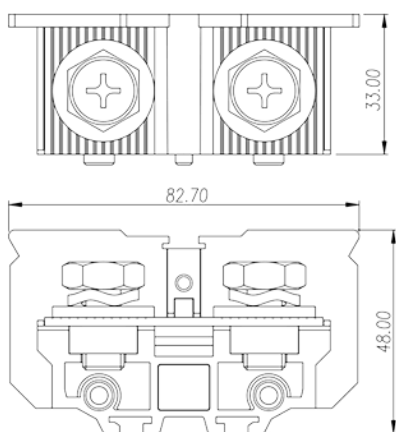

Approvals

