

DKB100N-XXPCK

NEMA Terminal Blocks > Panel Mounting

Date:2026-04-05

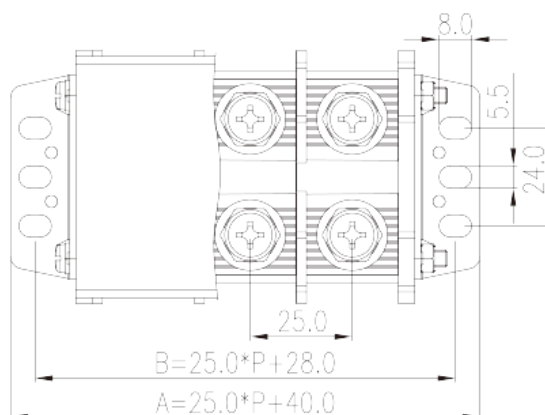
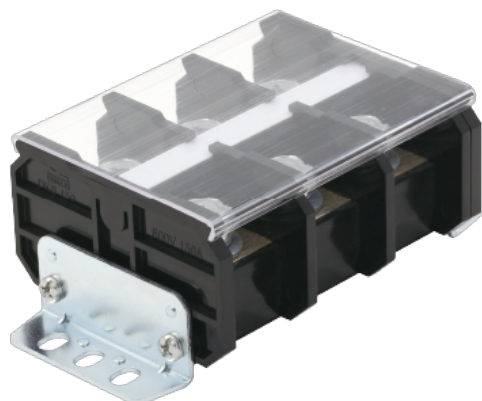

The web catalog is for reference only. Dinkle remains the right of product modification and engineering change of the design. The final product is made according to engineering drawing.

Product Description

Pitch : 25.00mm, M8, 600V, 200A

General information

Short description	Barrier terminals blocks, Panel Mounting
Category	Panel Mounting
Pitch (mm)	25.00
Color	Black (default)
Connection method	Screw connection
Type of locking	Panel Mounting
Length (mm)	25*P+40
Width (mm)	62
Height (mm)	44.7
Number of positions	02P~12P
Level	Single level
Connection points	4~24

Material information

Insulation material	PC
Insulation material group	IIIa

Flame retardant rating , compliant with UL94	V2
Insulation resistance	□1000MΩ at DC 500V
Conductor material	Copper Alloy
Plating of conductor surface	Ni plated

Connection data-IEC

Rated voltage (V)	800
Rated current (A)	150
Rated voltage (III/3)(V)	630
Rated impulse voltage (II/2)(KV)	8
Rated impulse voltage (III/2)(KV)	8
Rated impulse voltage (III/3)(KV)	8
Conductor cross section solid. min (mm ²)	10
Conductor cross section solid.max (mm ²)	50
Conductor cross section stranded. min (mm ²)	10
Conductor cross section stranded. max (mm ²)	50
2 conductors with same cross section, solid, max (mm ²)	50
2 conductors with same cross section, stranded, max (mm ²)	50
Screw thread	M8
Philips screwdriver size	PH3
Rated torque (N.m)	4.2
Recommend tightening torque. min (N.m)	3.5
Recommend tightening torque. max (N.m)	4.2
Stripping Length (mm)	20~21
Mounting rail	TS-35
End cover plate required	YES
Grounding connections	NO

Connection data-UL

Rated voltage (UL/CUL Group B)(V)	600
Rated current (UL/CUL Group B)(A)	200
Rated voltage (UL/CUL Group C)(V)	600
Rated current (UL/CUL Group C)(A)	200
Min. solid wire connection (AWG) acc. to UL/CUL	8

Max. solid wire connection AWG acc. to UL/CUL	3/0(With Ring terminals)
Min. stranded wire connection AWG acc. to UL/CUL	8
Max. stranded wire connection AWG acc. to UL/CUL	3/0(With Ring terminals)

Environment & Safety

Back of the hand protection (YES or NO)	YES
Finger protection (YES or NO)	NO
Operating temperature. max (°C)	125
Operating temperature. min (°C)	-40

UL Recognized

Wire Range (Group B)(AWG)	3/0(With Ring terminals)
Rated voltage (Group B)(V)	600
Rated current (Group B)(A)	200
Wire Range (Group C)(AWG)	3/0(With Ring terminals)
Rated voltage (Group C)(V)	600
Rated current (Group C)(A)	200

CUL Recognized

Wire Range (Group B)(AWG)	3/0(With Ring terminals)
Rated voltage (Group B)(V)	600
Rated current (Group B)(A)	200
Wire Range (Group C)(AWG)	3/0(With Ring terminals)
Rated voltage (Group C)(V)	600
Rated current (Group C)(A)	200

VDE Approval

Wire Range (mm ²)	10~50
Rated voltage (V)	800
Rated current (A)	150

Drawings

--	--

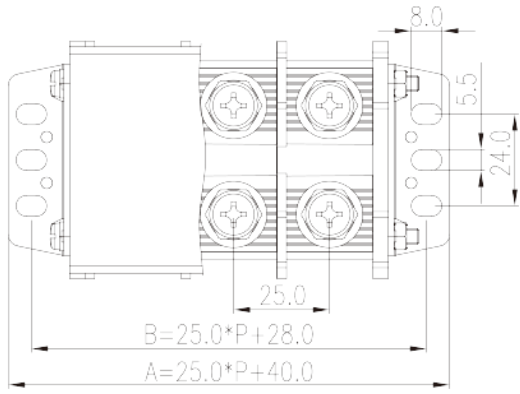

Approvals

