

DKB30N-XXPK

NEMA Terminal Blocks > Panel Mounting

Date:2026-04-06

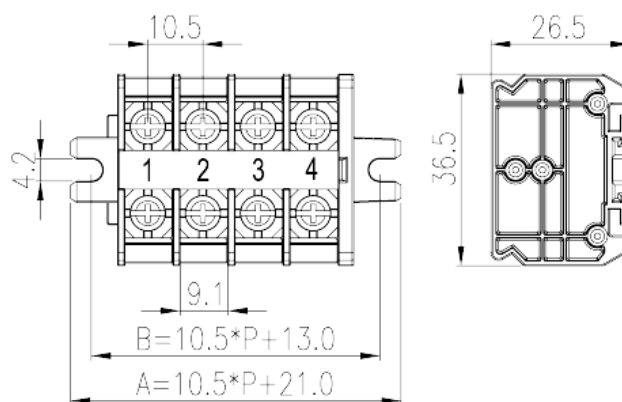

The web catalog is for reference only. Dinkle remains the right of product modification and engineering change of the design. The final product is made according to engineering drawing.

Product Description

Pitch : 10.50mm, M4, 600V, 30/40A

General information

Short description	Panel Mounting, Screw Connection
Category	Panel Mounting
Pitch (mm)	10.5
Color	Refer to drawing
Connection method	Screw Connection
Length (mm)	$10.50 * P + 21$
Width (mm)	36.5
Height (mm)	26.5
Number of positions	01P~16P
Level	Single level
Connection points	2~32

Material information

Insulation material	PC
Insulation material group	Ⅲa
Flame retardant rating , compliant with UL94	V2

Insulation resistance	□1000MΩ at DC 500V
Conductor material	COPPER ALLOY
Plating of conductor surface	Tin PLATED

Connection data-IEC

Rated voltage (V)	630
Rated current (A)	32
Rated voltage (III/3)(V)	630
Rated impulse voltage (III/3)(KV)	8
Conductor cross section solid. min (mm ²)	0.34
Conductor cross section solid.max (mm ²)	4
Conductor cross section stranded. min (mm ²)	0.34
Conductor cross section stranded. max (mm ²)	4
2 conductors with same cross section, solid, max (mm ²)	4
2 conductors with same cross section, stranded, max (mm ²)	4
Screw thread	M4
Philips screwdriver size	PH2
Rated torque (N.m)	1.2~1.5
Recommend tightening torque. min (N.m)	1.2
Recommend tightening torque. max (N.m)	1.5
Tightening torque with flange. max (N.m)	0.8
Stripping Length (mm)	12~13The stripping length depends on the specification provided by the cablelug manufacturer
Mounting rail	TS-35N · TS-35/15N
End cover plate required	YES
Grounding connections	NO

Connection data-UL

Rated voltage (UL/CUL Group B)(V)	600
Rated current (UL/CUL Group B)(A)	30
Rated voltage (UL/CUL Group C)(V)	600
Rated current (UL/CUL Group C)(A)	30
Rated voltage (UL/CUL Group D)(V)	600
Rated current (UL/CUL Group D)(A)	30
Min. solid wire connection (AWG) acc. to UL/CUL	22

Max. solid wire connection AWG acc. to UL/CUL	10
Min. stranded wire connection AWG acc. to UL/CUL	22
Max. stranded wire connection AWG acc. to UL/CUL	10

Environment & Safety

Back of the hand protection (YES or NO)	YES
Finger protection (YES or NO)	NO
Operating temperature. max (°C)	125
Operating temperature. min (°C)	-40

UL Recognized

Wire Range (Group B)(AWG)	22-10/(2)22-(2)12
Rated voltage (Group B)(V)	600
Rated current (Group B)(A)	30/40
Wire Range (Group C)(AWG)	22-10/(2)22-(2)12
Rated voltage (Group C)(V)	600
Rated current (Group C)(A)	30/40
Wire Range (Group D)(AWG)	22-10/(2)22-(2)12
Rated voltage (Group D)(V)	600
Rated current (Group D)(A)	5

CUL Recognized

Wire Range (Group B)(AWG)	22-10/(2)22-(2)12
Rated voltage (Group B)(V)	600
Rated current (Group B)(A)	30/40
Wire Range (Group C)(AWG)	22-10/(2)22-(2)12
Rated voltage (Group C)(V)	600
Rated current (Group C)(A)	30/40
Wire Ranget (Group D)(AWG)	22-10/(2)22-(2)12
Rated voltage (Group D)(V)	600
Rated current (Group D)(A)	5

Drawings

--	--

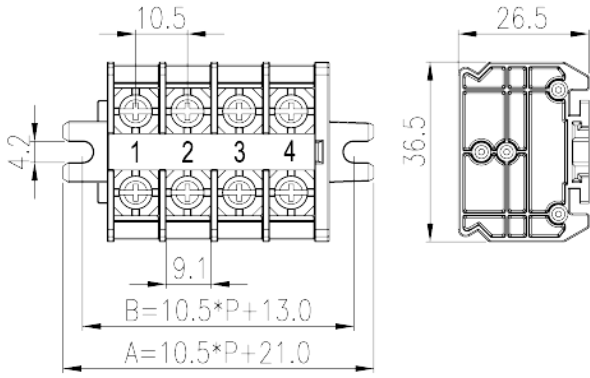

Approvals

