

# ECHP762V-XXP

PCB Terminal Blocks > PCB Connector-Socket

Date:2026-04-06

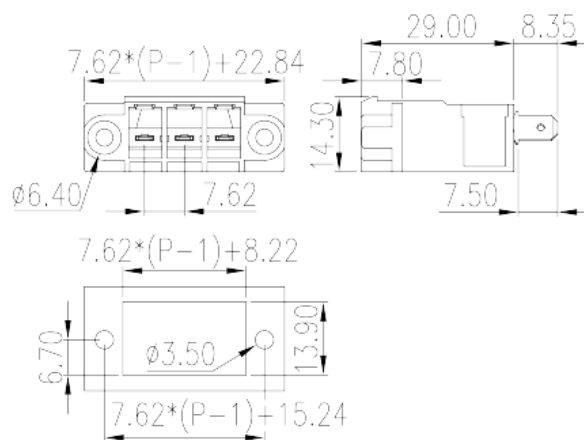
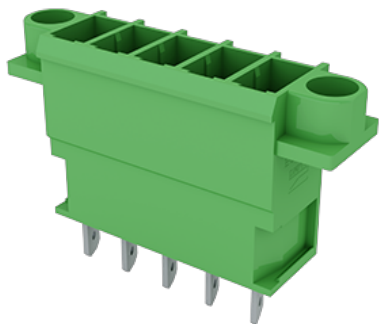

The web catalog is for reference only. Dinkle remains the right of product modification and engineering change of the design. The final product is made according to engineering drawing.

## Product Description

Pitch : 7.62mm, 300V, 30A

## General information

Short description	Connector – Socket, Slip-on connection
Category	PCB Connector – Socket
Pitch (mm)	7.62
Color	Green (default)
Connection method	Slip-on connection
Type of locking	With mounting flange
Length (mm)	$7.62*(P-1)+22.84$
Width (mm)	14.3
Height (mm)	37.35
Pin demensions (Thickness x Width)(mm)	0.8x4.8
Number of positions	02P~12P
Level	Single level

## Material information

Insulation material	PBT
Insulation material group	IIIa

Flame retardant rating , compliant with UL94	V0
Insulation resistance	□1000MΩ at DC 500V
Conductor material	COPPER ALLOY
Plating of conductor surface	Tin PLATED

## Connection data-IEC

Rated voltage (V)	800
Rated current (A)	41
Rated voltage (II/2)(V)	800
Rated voltage (III/2) (V)	630
Rated voltage (III/3)(V)	400
Rated impulse voltage (II/2)(KV)	6
Rated impulse voltage (III/2)(KV)	6
Rated impulse voltage (III/3)(KV)	6

## Connection data-UL

Rated voltage (UL/CUL Group B)(V)	300
Rated current (UL/CUL Group B)(A)	30
Rated voltage (UL/CUL Group C)(V)	300
Rated current (UL/CUL Group C)(A)	30
Rated voltage (UL/CUL Group D)(V)	600
Rated current (UL/CUL Group D)(A)	5

## Environment & Safety

Finger protection (YES or NO)	YES
Operating temperature. max (°C)	120
Operating temperature. min (°C)	-40

## UL Recognized

Rated voltage (Group B)(V)	300
Rated current (Group B)(A)	30
Rated voltage (Group C)(V)	300
Rated current (Group C)(A)	30
Rated voltage (Group D)(V)	600
Rated current (Group D)(A)	5

## CUL Recognized

Rated voltage (Group B)(V)	300
Rated current (Group B)(A)	30
Rated voltage (Group C)(V)	300
Rated current (Group C)(A)	30
Rated voltage (Group D)(V)	600
Rated current (Group D)(A)	5

## Drawings

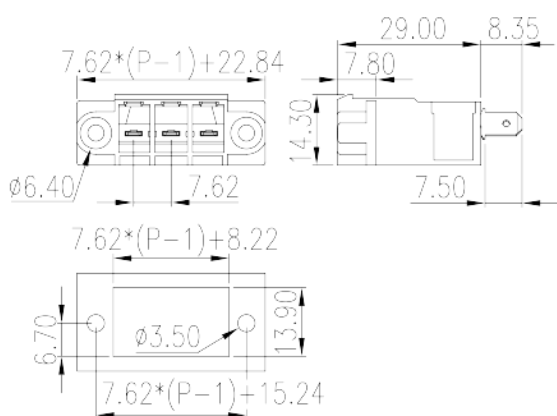

## Approvals

