

DK2.5-PE

DIN Rail Terminal Blocks > Screw Connection

Date:2026-04-06Version:1.2

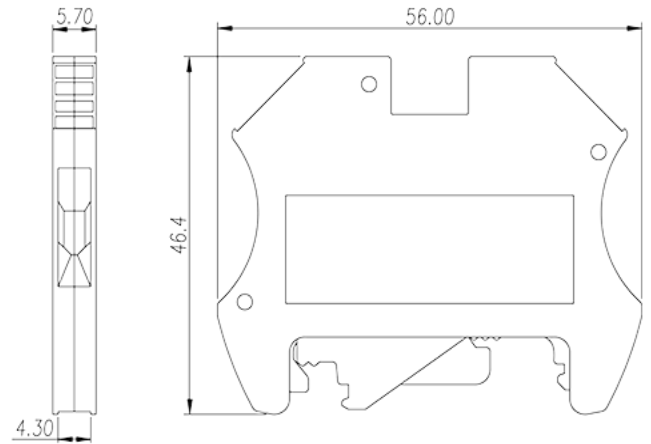
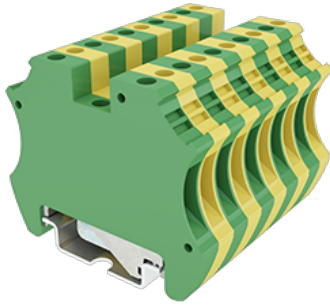

The web catalog is for reference only. Dinkle remains the right of product modification and engineering change of the design. The final product is made according to engineering drawing.

Product Description

M3, 600V, Green-Yellow (default)

General information

Short description	DIN rail terminal blocks, Grounding terminal blocks
Category	Grounding terminal blocks
Color	Green-Yellow (default)
Connection method	Screw connection
Type of locking	Rail mounting
Length (mm)	5.7
Width (mm)	56
Height (mm)	46.4
Level	Single level
Connection points	2

Material information

Insulation material	PA
Insulation material group	I
Flame retardant rating , compliant with UL94	V0
Insulation resistance	□500MΩ at DC 500V

Connection data-IEC

Rated impulse voltage (II/2)(KV)	8
Rated impulse voltage (III/2)(KV)	8
Rated impulse voltage (III/3)(KV)	8
Conductor cross section solid. min (mm ²)	0.5
Conductor cross section solid.max (mm ²)	2.5
Conductor cross section stranded. min (mm ²)	0.5
Conductor cross section stranded. max (mm ²)	2.5
Conductor cross section flexible, with min ferrule without plastic sleeve (mm ²)	0.5
Conductor cross section flexible, with max ferrule without plastic sleeve (mm ²)	2.5
Conductor cross section flexible, with min ferrule with plastic sleeve (mm ²)	0.5
Conductor cross section flexible, with max ferrule with plastic sleeve (mm ²)	2.5
2 conductors with same cross section, solid, max (mm ²)	1.5
2 conductors with same cross section, stranded, max (mm ²)	1.5
2 conductors with same cross section flexible, with min ferrule without plastic sleeve (mm ²)	0.5
2 conductors with same cross section flexible, with max ferrule without plastic sleeve (mm ²)	1.5
2 conductors with same cross section flexible, min twin ferrules with plastic sleeve (mm ²)	0.5
2 conductors with same cross section flexible, max twin ferrules with plastic sleeve (mm ²)	1
Screw thread	M3
Slotted screwdriver size (Blade thickness x Width)(mm)	0.6x3.5
Philips screwdriver size	PH1
Rated torque (N.m)	0.78
Stripping Length (mm)	10~14
Mounting rail	TS-35
End cover plate required	NO
Grounding connections	YES

Connection data-UL

Rated voltage (UL/CUL Group B)(V)	600
Rated voltage (UL/CUL Group C)(V)	600

Rated voltage (UL/CUL Group D)(V)	600
Min. solid wire connection (AWG) acc. to UL/CUL	26
Max. solid wire connection AWG acc. to UL/CUL	12
Min. stranded wire connection AWG acc. to UL/CUL	26
Max. stranded wire connection AWG acc. to UL/CUL	12

Environment & Safety

Back of the hand protection (YES or NO)	YES
Finger protection (YES or NO)	YES
Operating temperature. max (°C)	120
Operating temperature. min (°C)	-40

UL Recognized

Wire Range (Group B)(AWG)	26~12
Rated voltage (Group B)(V)	600
Wire Range (Group C)(AWG)	26~12
Rated voltage (Group C)(V)	600
Wire Range (Group D)(AWG)	26~12
Rated voltage (Group D)(V)	600

CUL Recognized

Wire Range (Group B)(AWG)	26~12
Rated voltage (Group B)(V)	600
Wire Range (Group C)(AWG)	26~12
Rated voltage (Group C)(V)	600
Wire Ranget (Group D)(AWG)	26~12
Rated voltage (Group D)(V)	600

VDE Approval

Wire Range (mm ²)	0.5~2.5
-------------------------------	---------

Drawings

--	--

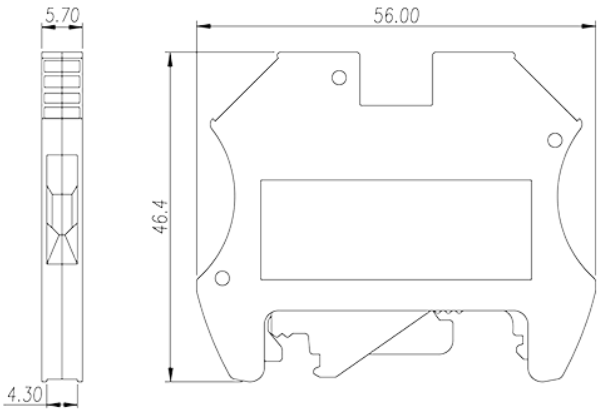

Approvals

