

P-861

栅板式端子 > 独立端子

下载日期:2026-04-05版次:1.2

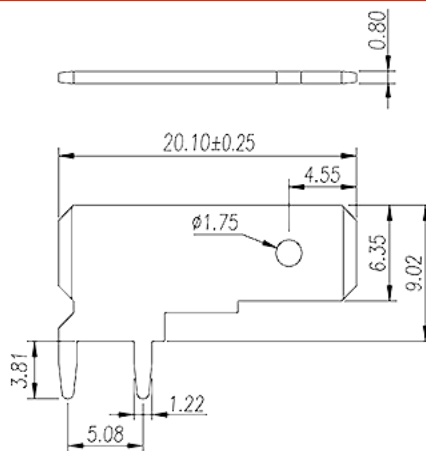

目录仅供参考，实际规格仍依照产品工程图面为准

产品介绍

Pitch : 5.08mm, 0.8x1.22mm, 30A

一般资讯

产品概述	Barrier terminal blocks, Quick terminal blocks
产品类型	Quick terminal blocks
产品间距 (mm)	5.08
引脚尺寸 (厚度___ x 宽度___mm)	0.8x1.22

材料信息

导体材料	COPPER ALLOY
导体表面镀层	Tin PLATED

连接数据-IEC

额定电流 (A)	30
----------	----

图面

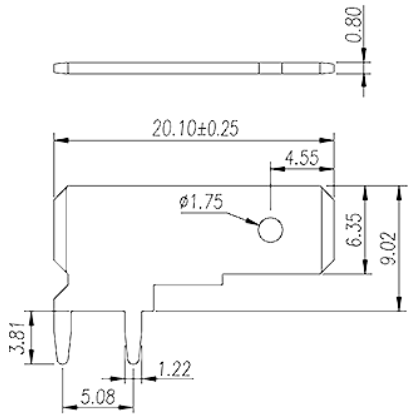

认证

